



PDB+



Power distribution – finger-safe and individually adjustable

PDB+

Engineering Excellence meets Modern Design! The new FTG single pole compact Power Distribution Block includes many new innovative refinements including Selectable Phase Identification, Color Marking Plates, Simple and Secure DIN Mounting Clip, Incoming Cable Safety Slide, and Connection Clip for multipole applications..

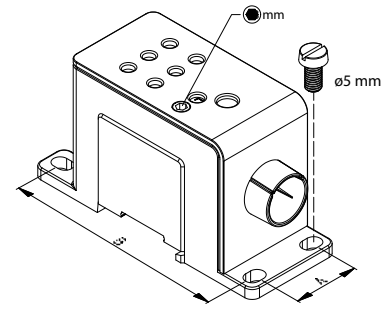

- Adjustable Dial allows for Selection of L1–L2–L3 phase designation

- Color Marking Plates in Brown,Black or Grey

- Simple and secure DIN rail locking clip allows easy mounting on DIN Rail

- Incoming Cable Safety Slide assures IP20 protection with all conductor sizes

- Connection Clip included with each PDB for Multipole applications

- Suitable for Aluminum and Copper conductors

Technical Data

UL Rating	UL Listed to 1953 file QPQS - E483207
UL Voltage Rating	1000VAC / DC
PDB Block Material	Tin plated Aluminum
Suitable Conductors	Copper or Aluminum
Housing Color	light grey / dark grey

Short circuit resistance

The PDB+ have been investigated for **high short circuit current ratings** according to IEC. They have a 100 kA SCCR rating with specific overcurrent protection device.

Part #	38680	38682	38684	38686	38688
Icw	300 A	6.000 A	8.400 A	14.400 A	28.800 A
Ipk	35 kA	36,1 kA	40,8 kA	47,7 kA	57,2 kA
SCCR	100 kA	100 kA	100 kA	100 kA	100 kA



38680



38682





38684



38686





38688

Part #	Amp Rating	Ø (mm)	Cross section (mm ²)		A (mm)	B (mm)
						
38680	80 A Cu	1 x 10,5	2,5 mm ² - 25 mm ² 14 AWG - 3 AWG	2,5 mm ² - 25 mm ² 14 AWG - 3 AWG	23,2	79,2
38680C*	63 A Al	6 x 4,4	2,5 mm ² - 10 mm ² 14 AWG - 8 AWG	1,5 mm ² - 6 mm ² 14 AWG - 10 AWG		
38682	125 A Cu	1 x 10,5	2,5 mm ² - 50 mm ² 14 AWG - 1 AWG	2,5 mm ² - 35 mm ² 14 AWG - 2 AWG	23,2	79,2
38682C*	100 A Al	6 x 7,0	2,5 mm ² - 25 mm ² 14 AWG - 4 AWG	2,5 mm ² - 16 mm ² 14 AWG - 6 AWG		
38684	175 A Cu	1 x 12,5	2,5 mm ² - 70 mm ² 14 AWG - 2/0 AWG	2,5 mm ² - 50 mm ² 14 AWG - 1/0 AWG	23,2	88,7
38684C*	135 A Al	4 x 8,5	2,5 mm ² - 35 mm ² 14 AWG - 2 AWG	2,5 mm ² - 25 mm ² 14 AWG - 4 AWG		
38686	250 A Cu	1 x 16,5	35 mm ² - 120 mm ² 2 AWG - 250 kcmil	35 mm ² - 95 mm ² 2 AWG - 4/0 AWG	41,2	103,7
38686C*	200 A Al	6 x 8,5	2,5 mm ² - 35 mm ² 14 AWG - 2 AWG	2,5 mm ² - 25 mm ² 14 AWG - 4 AWG		
38688	415 A Cu	1 x 22,5	70 mm ² - 240 mm ² 2/0 AWG - 500 kcmil	70 mm ² - 185 mm ² 2/0 AWG - 400 kcmil	41,2	103,7
38688C*	360 A Al	6 x 8,5	2,5 mm ² - 35 mm ² 14 AWG - 2 AWG	2,5 mm ² - 25 mm ² 14 AWG - 4 AWG		

*Add "C" to PDB+ part # to include Brown, Black and Grey Marking Plates (1 each) with the PDB, or order Marking Plates separately using part #s below 

Marking Plates

Part #	Description
C38BL	10 x Marking plate blue 
C38RT	10 x Marking plate red 
C38GN	10 x Marking plate green 



38682 + C38BL



38680 + C38RT



38684 + C38GN

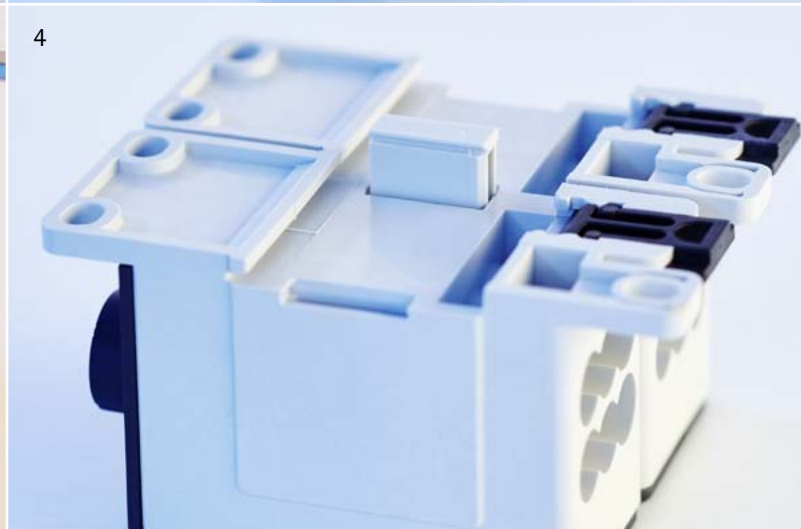
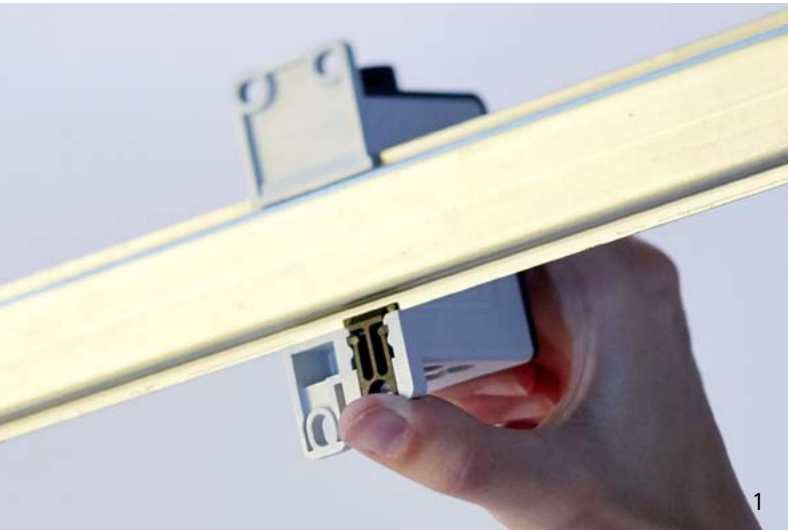

1 Safe mounting on DIN Rail through DIN Rail locking clip | 2 Safety Slide assures IP20 protection with all conductor sizes | 3 Integrated, adjustable phase marking
4 Connection Clips secure single pole PDBs for multiphase applications

FTG – Friedrich Göhringer
Elektrotechnik GmbH
Gerwigstr. 8
DE-78098 Triberg
Germany
Phone +49 (0) 7722 96 36 0
Fax +49 (0) 7722 96 36 36
www.ftg-germany.de

